

**RR1**

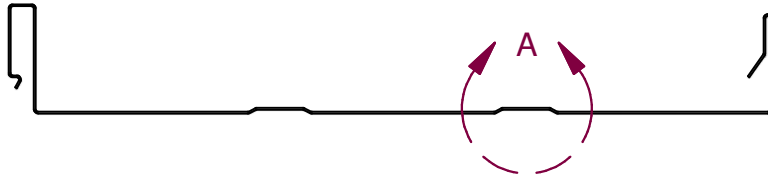

**RR2**

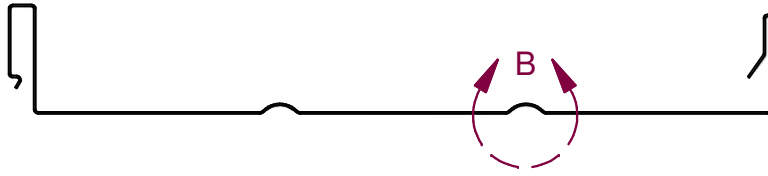

**RR3**

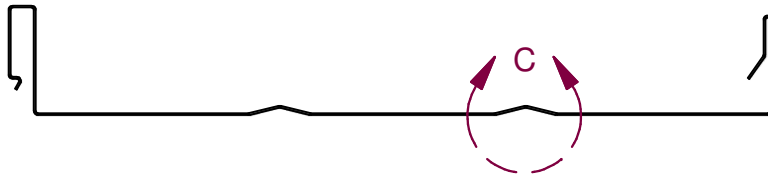

**RR4**

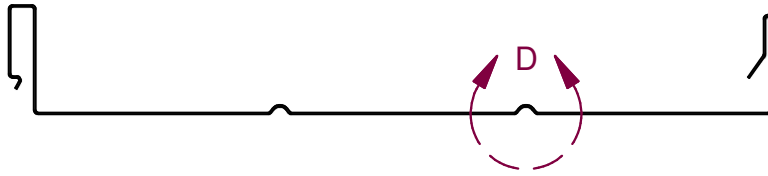

**RR5**

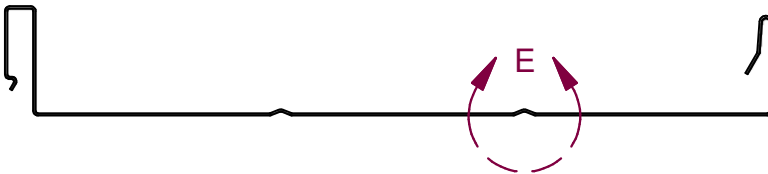

**RR6**

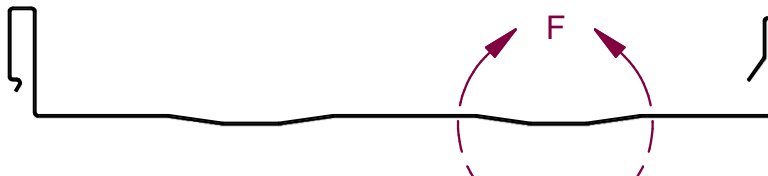

**RR7**

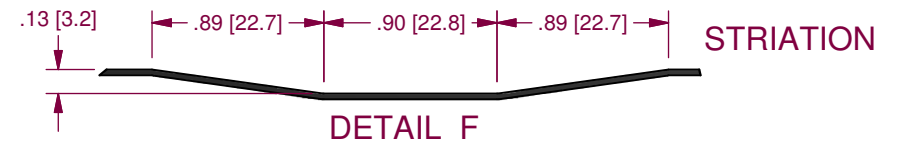
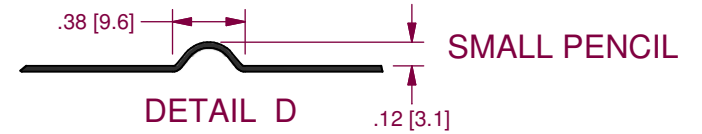
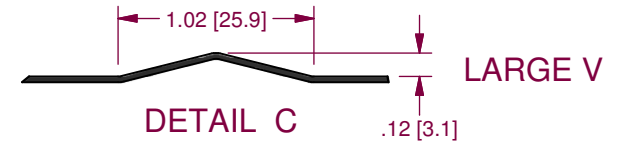
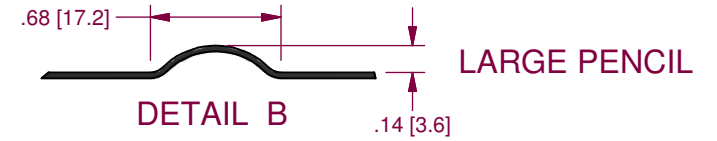
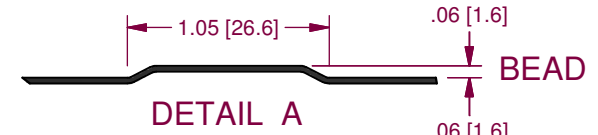
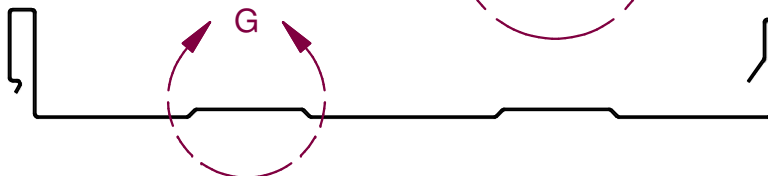

- NOTES:
1. ALL RIB ROLLERS CAN BE USED WITH ANY PANEL PROFILE.
  2. METRIC DIMENSIONS ARE SHOWN IN [ BRACKETS ].

REVISION HISTORY	REV	ECR NO.	DATE	RELEASED BY
	1	ADD METRIC	10-29-07	JD
	2	ADD SHT 2	05-29-09	JD
	3	R-1653	06-26-09	AJB

TOLERANCES
.XX = ± .01
.XXX = ± .005
FRACTION = ± 1/32"
ANGLE = ± 1/2'

		<b>NEW TECH MACHINERY CORP.</b>	
DRAWN BY JD	DATE 10-26-07	PART NAME <b>RIB ROLLERS</b>	
CHECK BY FRY	DATE 10-26-07	PART NUMBER <b>RIB ROLLERS</b>	SHEET <b>1 OF 2</b>
		REVISION <b>3</b>	

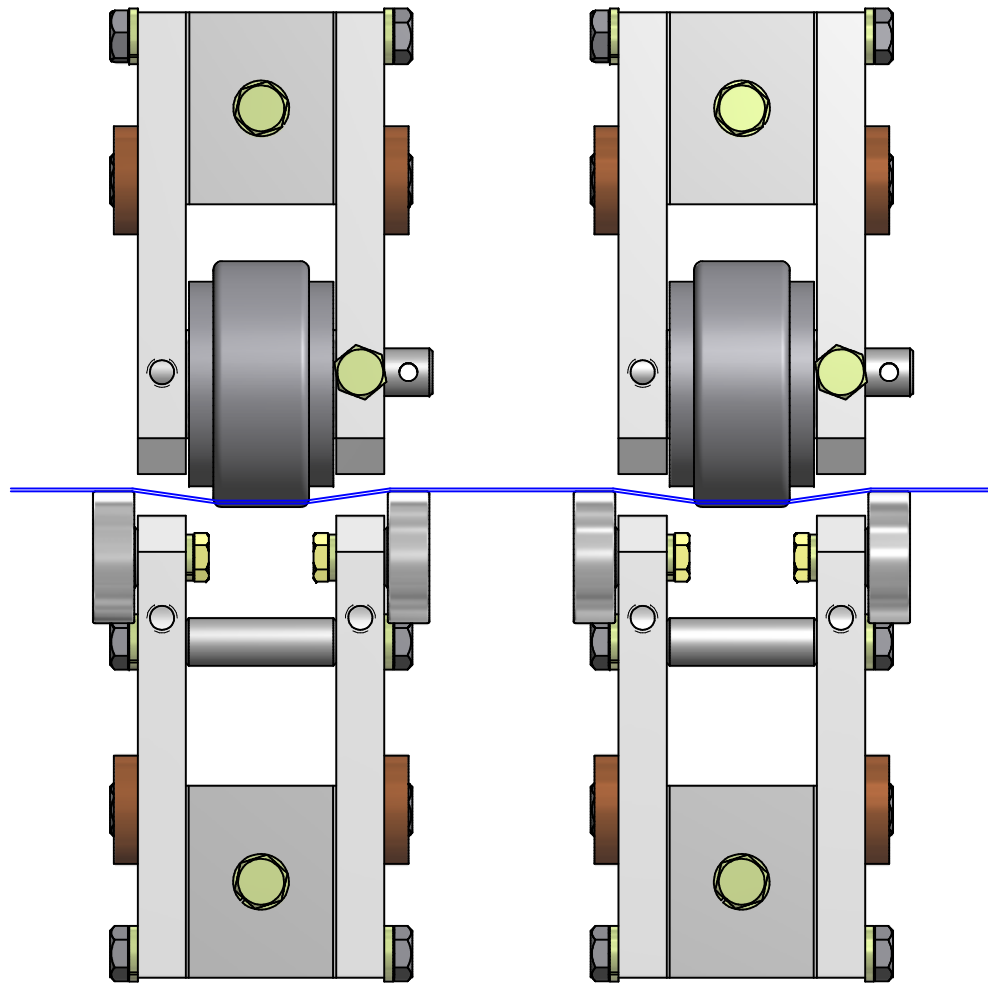

**RR6**  
SEE SHT 1  
DETAIL F

**NOTES:**

1. ALL RIB ROLLERS CAN BE USED WITH ANY PANEL PROFILE.
2. METRIC DIMENSIONS ARE SHOWN IN [ BRACKETS ].

REVISION HISTORY	REV	ECR NO.	DATE	RELEASED BY

TOLERANCES
.XX = ± .01
.XXX = ± .005
FRACTION = ± 1/32"
ANGLE = ± 1/2'

		<b>NEW TECH MACHINERY CORP.</b>	
DRAWN BY GDP	PART NAME <h2 style="text-align: center;">RIB ROLLERS</h2>		
DATE 05-29-09	CHECK BY	PART NUMBER <h2 style="text-align: center;">RIB ROLLERS</h2>	SHEET <b>2 OF 2</b>
DATE			REVISION <h1 style="text-align: center;">3</h1>